



Electrolux
PROFESSIONAL

Modular Cooking Range Line 900XP Electric Induction Wok - 400 mm

ITEM # _____

MODEL # _____

NAME # _____

SIS # _____

AIA # _____



391353 (E9INEDW00P)

Electric single Induction Wok
(5 kW)

Short Form Specification

Item No. _____

Heavy duty glass ceramic wok bowl powered by a 5 kW inductor with overheating safety device. Induction top to maximize heat transfer to the food and reduce energy consumption in stand-by mode. Unit features Pan Detection system: inductor is activated only when an induction-friendly wok pan is placed on the bowl. Side and rear panels of unit entirely in AISI 304 stainless steel with Scotch Brite finish. Extra strength work top in heavy duty 2 mm AISI 304 stainless steel. Right-angled side edges to allow flush-fitting junction between units.

Main Features

- Heavy duty glass-ceramic wok bowl
- 5kW inductor endowed with overheating safety device.
- Reduced heat emission in the work environment.
- Pan detection system - the inductor is switched on only when an induction-friendly wok pan is placed on the bowl.
- IPX5 water protection.
- Pots diameter to be used : min 12cm, max 28 cm in order to obtain maximum heating efficiency.
- Suitable for countertop installation.

Construction

- Side and rear panel in AISI 304 stainless steel.
- All the functional components are accessible via the front of the appliance.
- Unit is 930 mm deep to give a larger working surface area.
- AISI 304 stainless steel worktop, 2mm thick.
- Model has right-angled side edges to allow flush fitting joints between units, eliminating gaps and possible dirt traps.
- All exterior panels in Stainless Steel with Scotch Brite finishing.

Sustainability



- High efficiency (up to 90%) induction heating system maximizes the heat transferred to the food and reduces energy consumption in stand-by mode.
- This model is compliant with Swiss Energy Efficiency Ordinance (730.02).

Optional Accessories

- Junction sealing kit PNC 206086
- Support for bridge type installation, 800mm PNC 206137
- Support for bridge type installation, 1000mm PNC 206138
- Support for bridge type installation, 1200mm PNC 206139
- Support for bridge type installation, 1400mm PNC 206140
- Support for bridge type installation, 1600mm PNC 206141
- Support for bridge type installation, 400mm PNC 206154
- Induction Wok pan with wooden handle (diam. 360mm) PNC 910613
- Stainless steel wok pan, design in line with wok cuvette PNC 911000

APPROVAL: _____



Experience the Excellence
www.electroluxprofessional.com



Electrolux
PROFESSIONAL

**Modular Cooking Range Line
900XP Electric Induction Wok - 400
mm**

- Non-stick wok pan, design in line with wok cuvette PNC 911003
- Inducton Wok pan with stainless steel handle (diam. 360mm) PNC 911587
- Stainless steel lid for Wok pan diam. 360mm PNC 911588



**Modular Cooking Range Line
900XP Electric Induction Wok - 400 mm**

The company reserves the right to make modifications to the products without prior notice. All information correct at time of printing.

2025.07.02

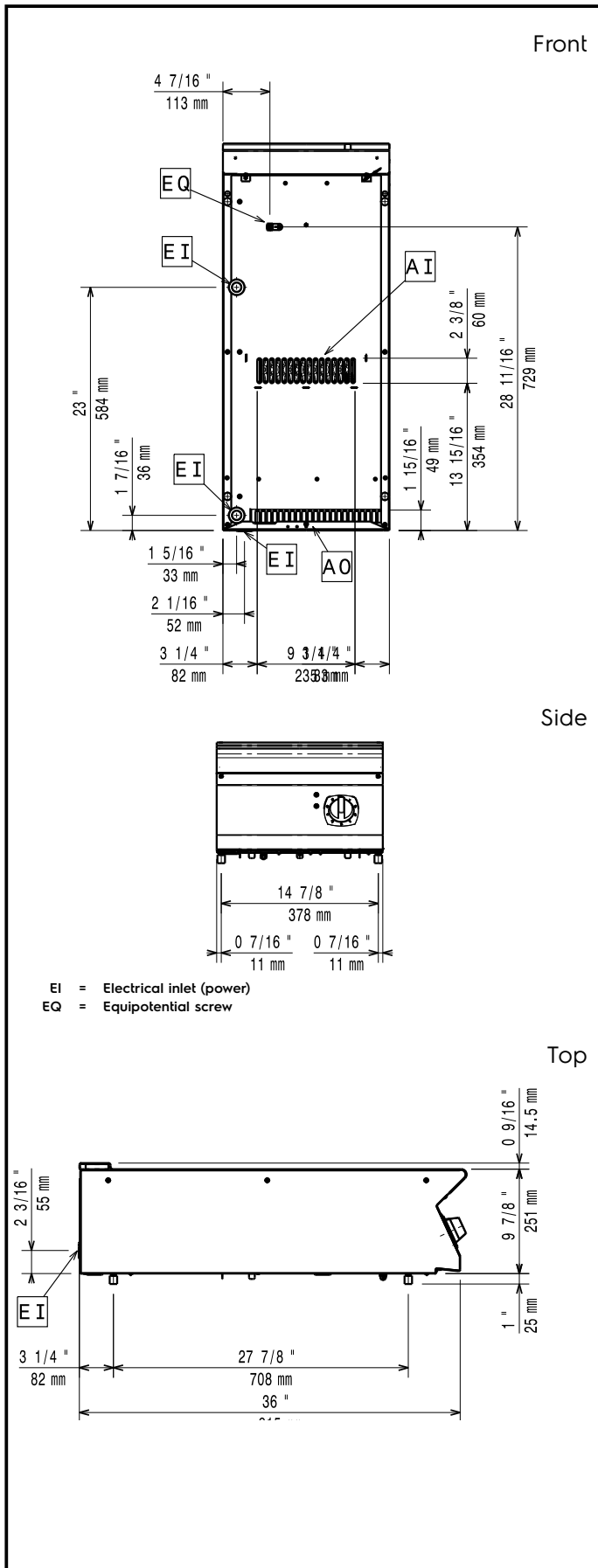

Electric

Supply voltage:	380-400 V/3 ph/50/60 Hz
Predisposed for:	380-400V 3- 50/60Hz 5kW
Total Watts:	5 kW

Key Information:

Induction compatible pots & pans must be used.

External dimensions, Width:	400 mm
External dimensions, Depth:	930 mm
External dimensions, Height:	250 mm
Net weight:	30 kg
Certification group:	N9CIN
Back Plates dimensions:	Ø 300
Induction Top Dimensions (width):	400 mm
Induction Top Dimensions (depth):	930 mm